

## **Observing Intrinsic Transport Properties of Single-Crystal Organic Semiconductors using Air-Gap Dielectric FETs**

C. Corcoran, T. Takenobu, and Y. Iwasa

Institute for Materials Research, Tohoku University, Sendai, Japan

In organic FETs, charge-carrier traps often form at the interface between a semiconductor organic single crystal and the dielectric layer, reducing the charge-carrier mobility and disrupting observation of the intrinsic-like transport properties of the material; furthermore, these traps inhibit electron injection in most organic semiconductors. Buffer layers, such as PMMA, have been used to reduce the number of electron traps and alleviate this problem with moderate success. A more drastic approach is to eliminate the interface, creating an “Air-gap” transistor, which uses a vacuum or inert gas as the dielectric layer. A patterned PDMS elastomer is used to create the raised surface containing a gap, which is bridged by a single crystal of rubrene (or other organic semiconductors). Work with this type of device has yielded intrinsic hole mobilities as high as  $20 \text{ cm}^2\text{V}^{-1}\text{s}^{-1}$  along the b-axis, using four-point probing to separate out the transport effects of the contacts. Further observation of these high-mobility devices would help advance the understanding of the physics of charge transport in these organic semiconductors. Furthermore, with particular electrode materials and configuration, ambipolarity may be achieved, simultaneously injecting both holes and electrons into the channel. Observing ambipolar behavior with such high-mobility devices may also aid in the quest for organic LASERS.

## Why Organic Electronics?

Organic Devices

- LEDs
  - FETs
  - Solar Cells
- Advantages
- Cheaper
  - Flexible
  - Environmentally friendly

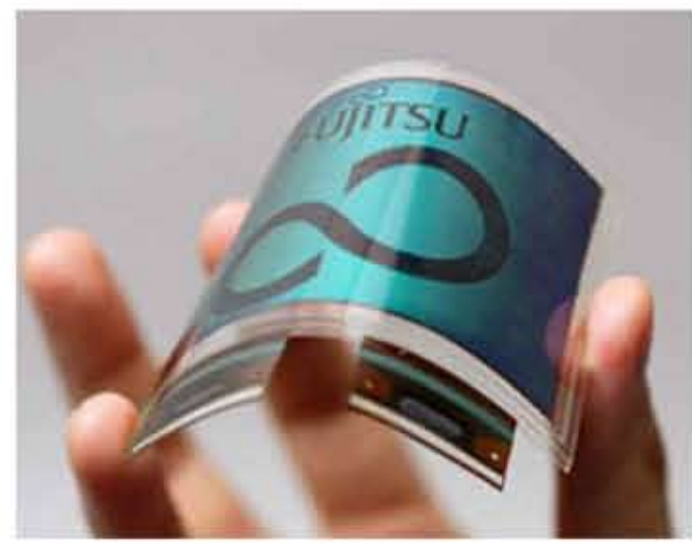

## Field Effect Transistor (FET)

- $V_D$  applied across source and drain
- $V_G$  builds charge between gate and semiconductor
- Resulting Electric field controls current through the semiconductor ( $I_D$ )
- The relationship between  $I_D$ ,  $V_D$ , and  $V_G$  reveals characteristics of the semiconducting material, such as mobility.

## Goals

- 1) Grow rubrene single crystals
- 2) Fabricate and characterize organic FET devices
  - Lamination
  - Air gap
- 3) Estimate inherent physical properties of rubrene

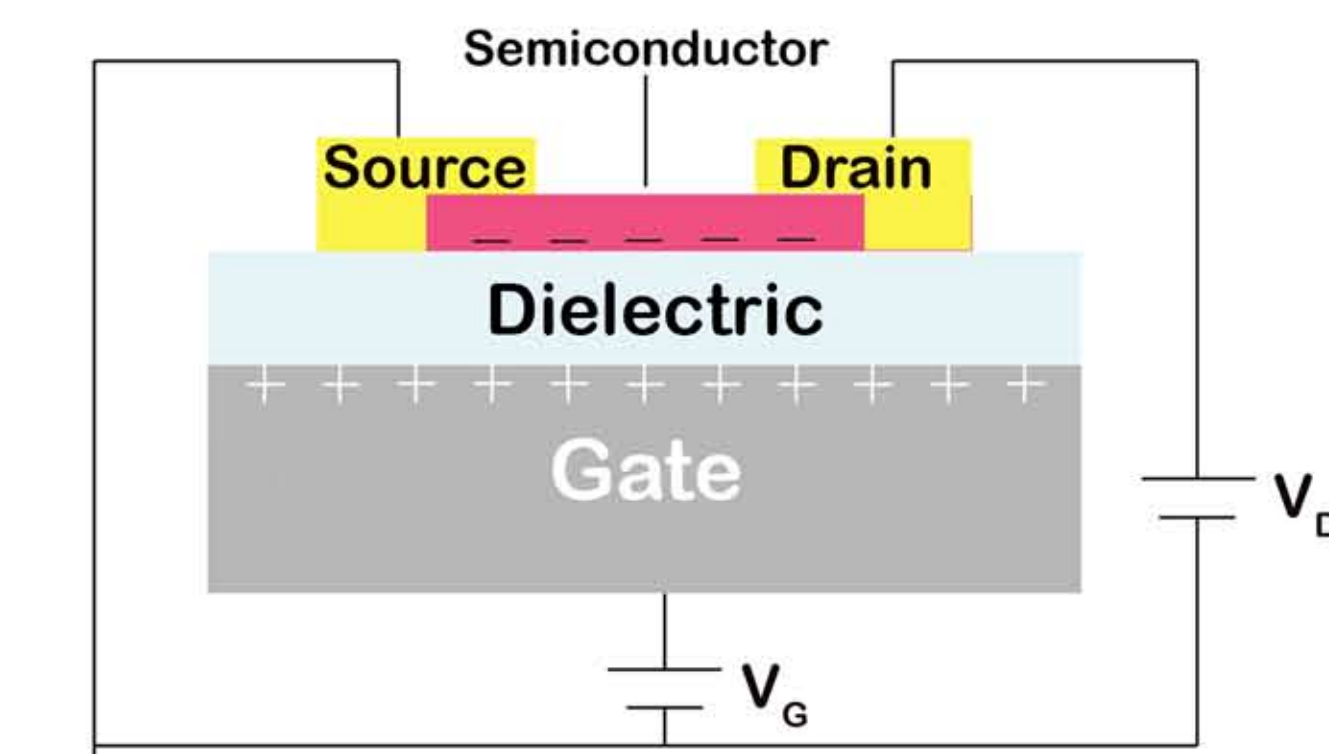

Fig. 1a, FET set up

## Why Single Crystals?

- Eliminates grain boundaries
- Reduces charge traps
- Increases mobility
- Closer to inherent characteristics

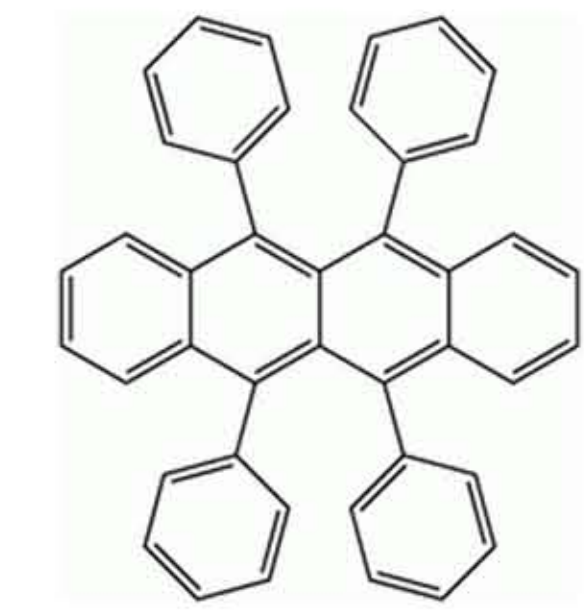

Fig. 1b, Rubrene Crystal

## FET Devices

### Lamination devices

- Crystal laminated directly onto dielectric.
- Thermally deposited Au or hand-applied Ag paste form the electrodes.
- Charge-carrier traps occur at crystal-dielectric interface.
- Charge-carrier traps cause lower mobility.

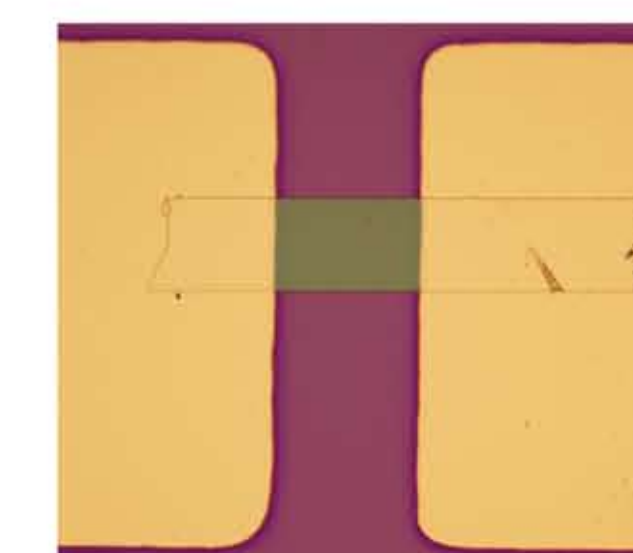

Fig. 1c, Au top contact FET similar to fig 1a.

### Air Gap devices

- Au thermally deposited onto PDMS substrate, simultaneously creating source, drain, and gate.
- "Air" (usually inert gas or vacuum) is dielectric.
- No solid interface across the channel, reducing charge-carrier traps.
- Closer to inherent characteristics of semiconductor.

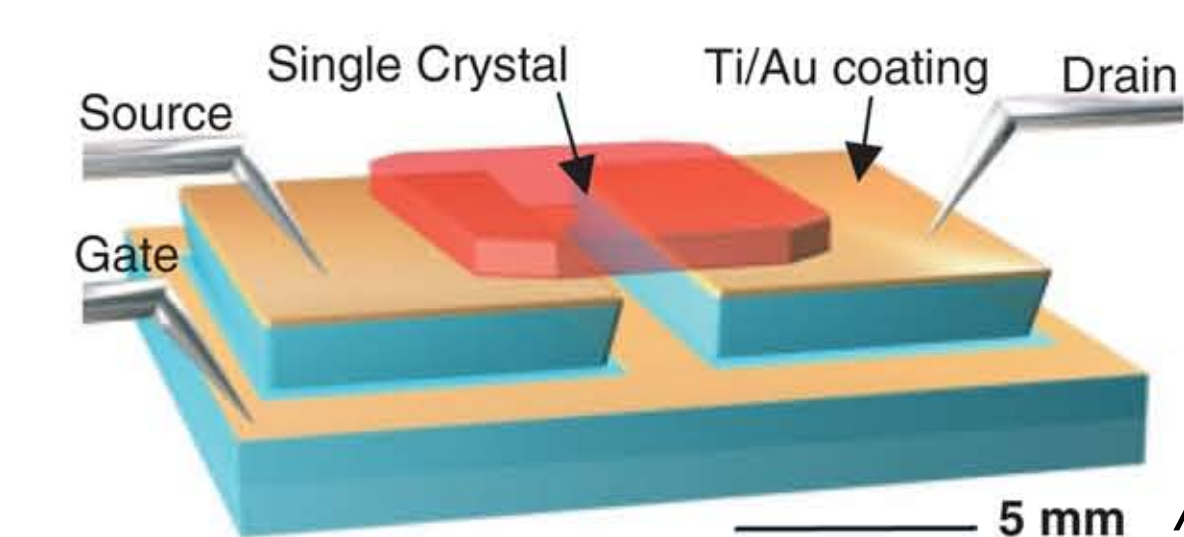

Fig. 1d, Bottom contact air gap FET  
J. Rogers et al  
*Adv. Mater.* **2004**, 16, 2098

## Crystal Growth: Physical Vapor Transport

- Temperature difference
- Inert gas flows through tube
- Powder sublimated into gas
- Rubrene nucleates, forms crystals

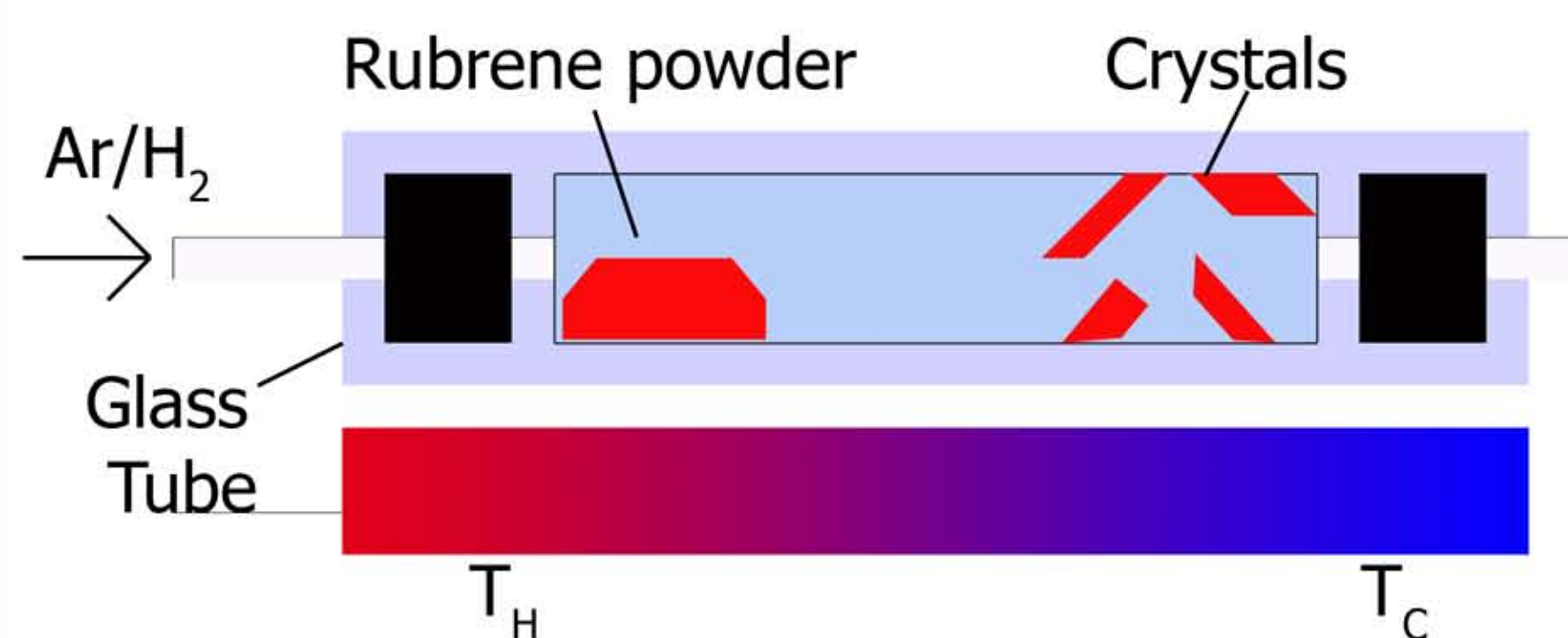

Fig 2a, Diagram of PVT

To grow larger and more pure crystals, we needed a new type of furnace.

### Old Furnace:



Fig. 2b, Two ovens at  $T_H$  and  $T_C$ , Insulation gap causes large T drop (see fig. 2d).

### New Furnace:

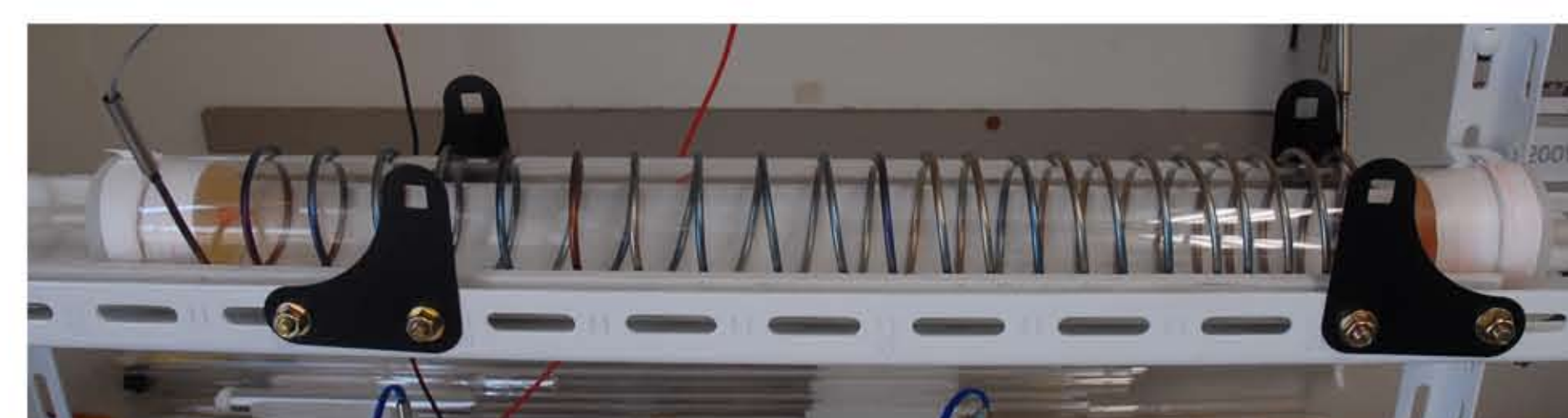

Fig. 2c, Heating filament wrapped around glass tube. Decreasing density of coils causes gradual T drop.

## Construction of a New Furnace

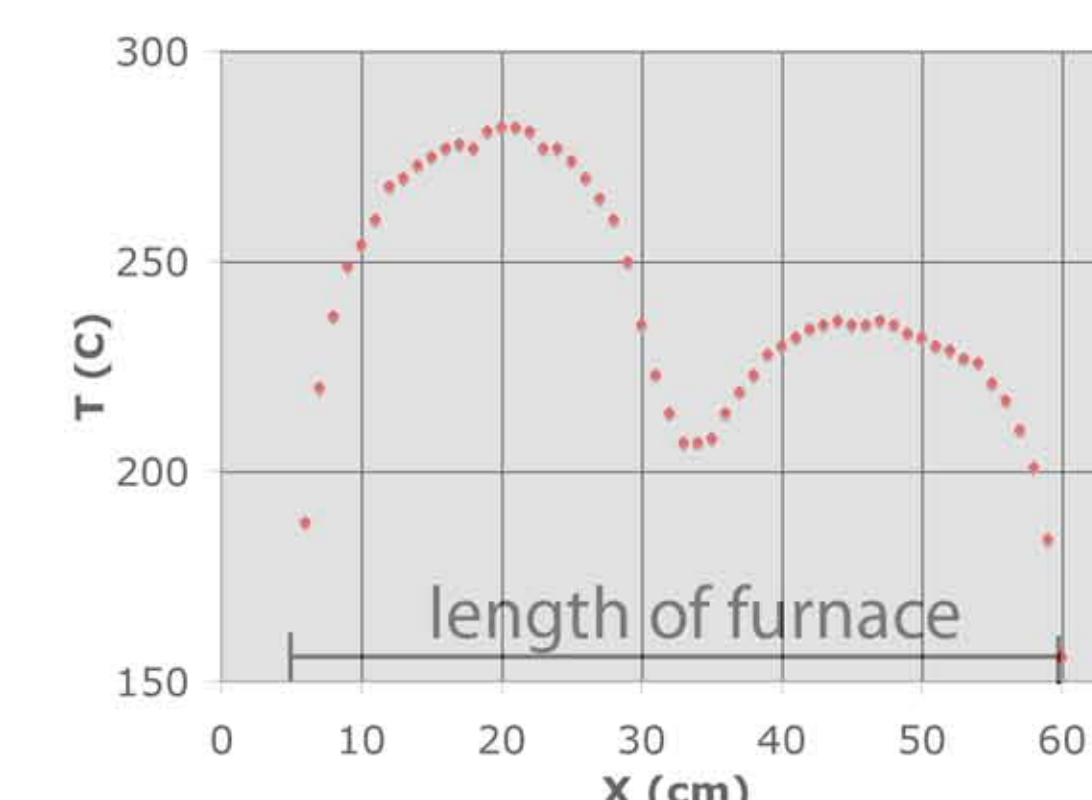

Fig. 2d, Rubrene as well as impurities will deposit at T dip.

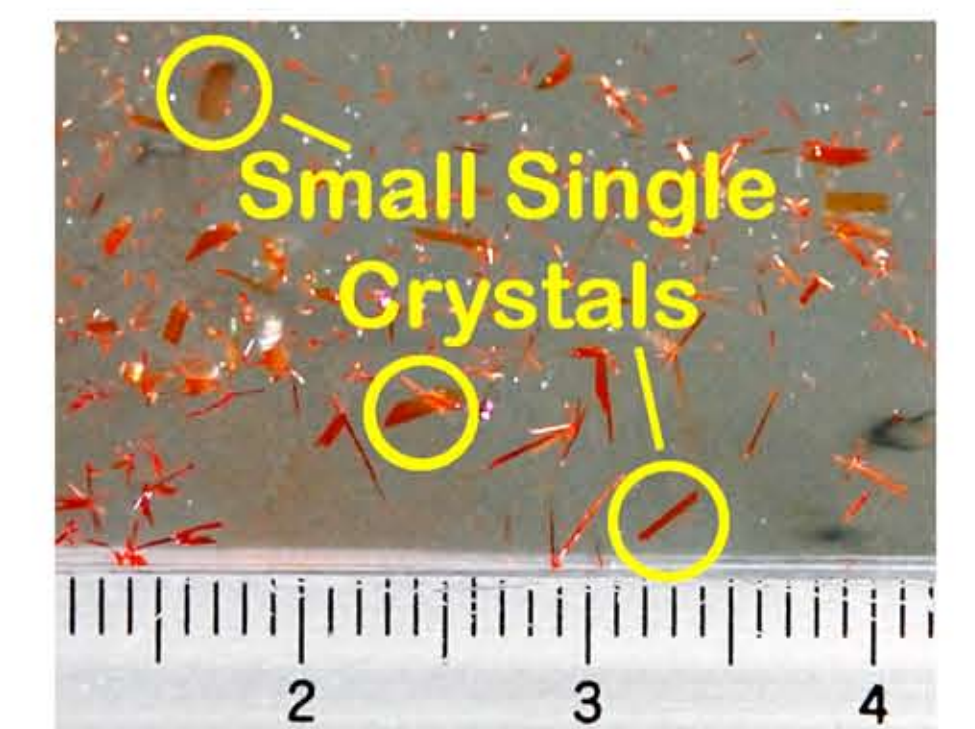

Fig. 2f, smaller crystals grown in old furnace.

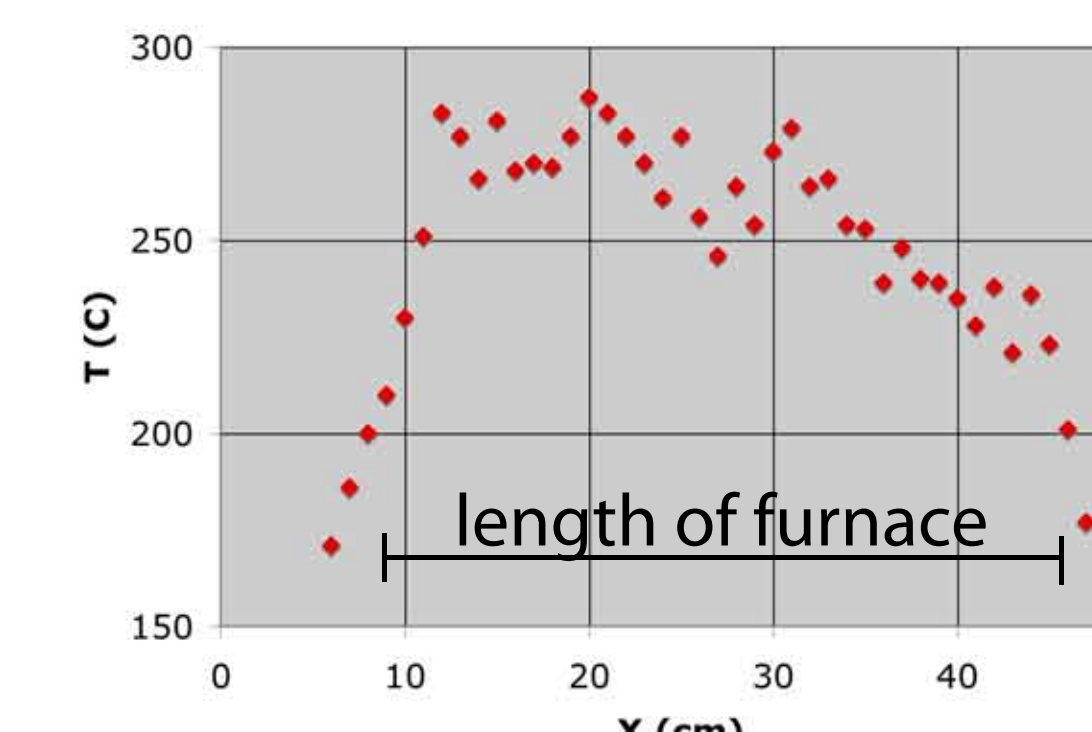

Fig. 2e, Impurities deposit farther from crystal growth, yielding higher-quality crystals.



Fig. 2g, More control allows for larger crystal growth.

## Device Characterization

### Output Characteristic Curve

- $V_D$  vs  $I_D$ , varying  $V_G$
- General behavior
- Saturation region

### Transport Curve

- $V_G$  vs  $I_D$
- Calculate mobility



(above) Fig. 3a, Preparing FET devices  
(right) Fig. 3b and c, Typical results for p-channel Output and Transfer curves.

Output Curve of p-channel Ag Paste Device

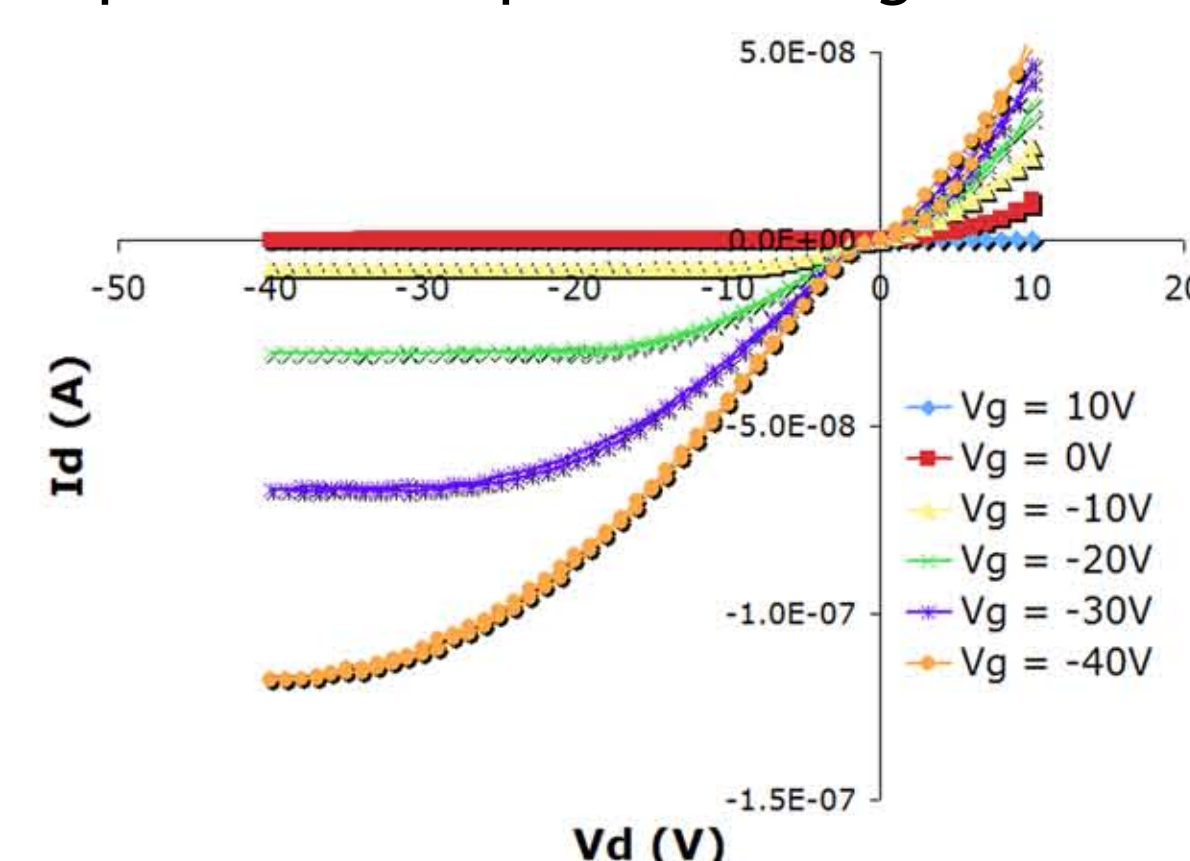

Transfer Curve of p-channel Ag Paste Device

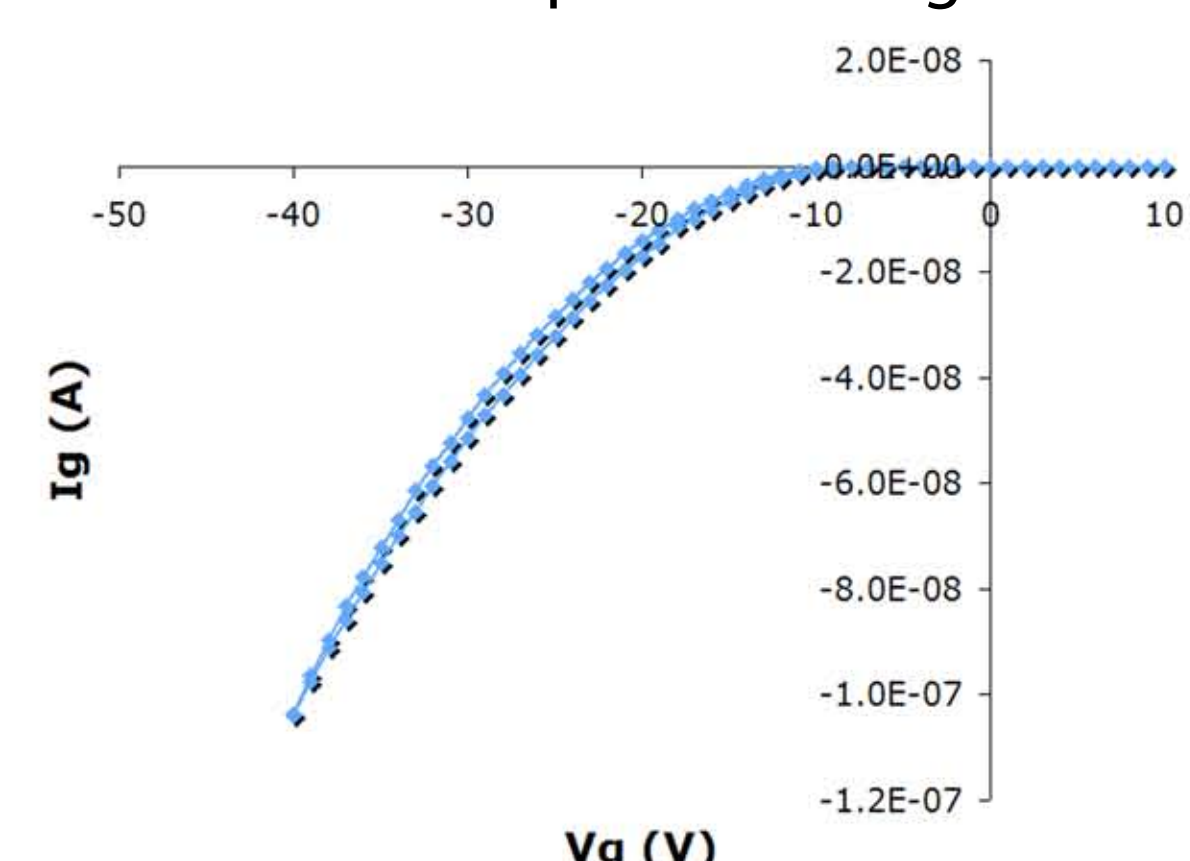

$\mu$  (mobility) =  $1.077 \text{ cm}^2\text{V}^{-1}\text{s}^{-1}$

## Air Gap Device Difficulties

- Significant leak current was measured between the source, drain, and gate.
- Upon SEM imaging (fig. 3g) this was found to be caused by faulty PDMS substrates (fig. 3e).

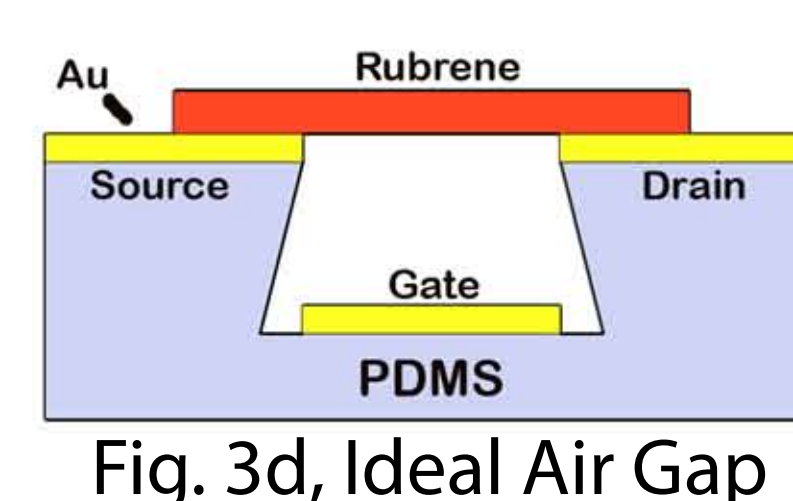

Fig. 3d, Ideal Air Gap

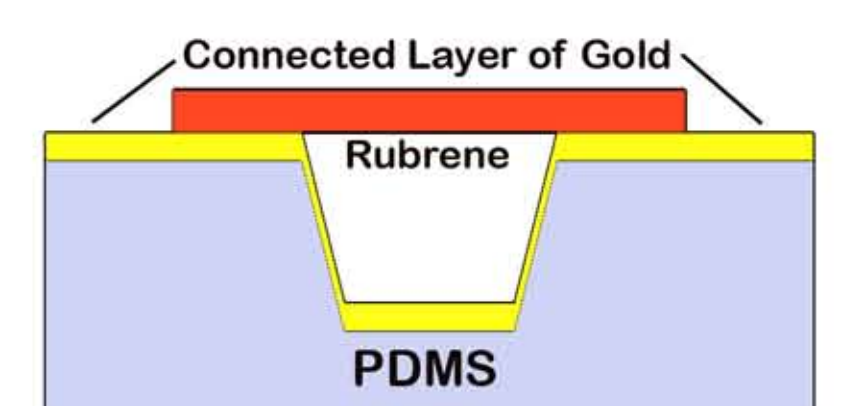

Fig. 3e, Faulty devices used

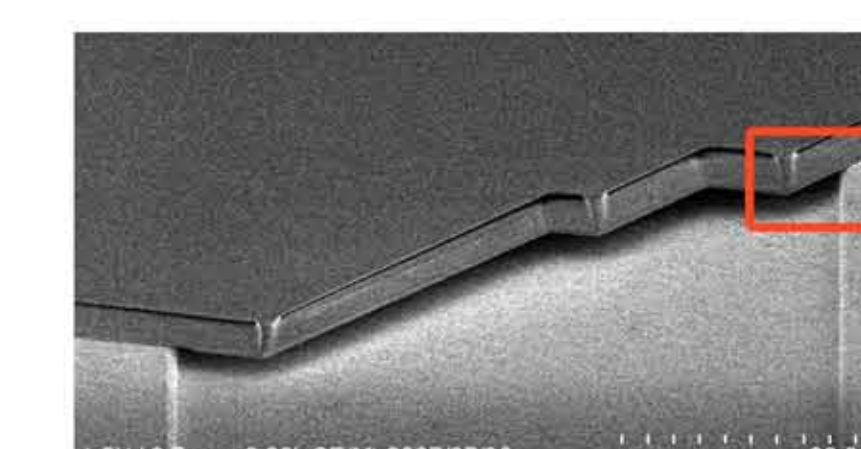

Fig. 3f, SEM image of air gap

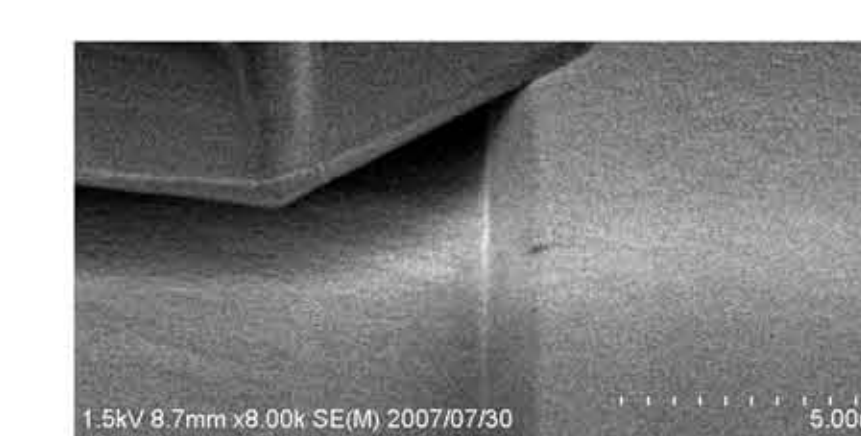

Fig. 3g, Au connecting drain and gate

## Conclusions

I was successful in creating a furnace to grow larger and purer crystals for air gap transistors. I was able to fabricate and characterize several different types of lamination devices, achieving relatively high mobilities. The air gap transistors failed, but we were able to find the source of the problem and what we need to do to correct it.

## Future Work

- Continue to optimize growing conditions in the new furnace.
- Improve structure of PDMS substrates.
- Create air gap top contact devices.
- Look for ambipolar behavior with air gap transistors.

Research conducted at Tohoku University as a participant in the Rice University and NSF-PIRE sponsored NanoJapan 2007 program